

50x50x20mm

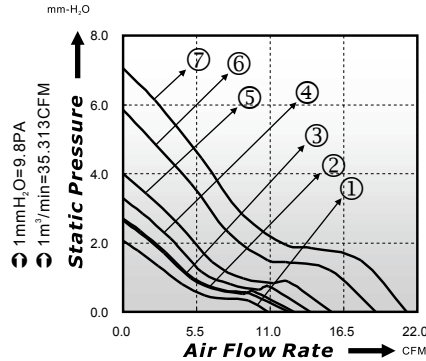

■ P-Q Curve (At Rated Voltage)



■ Dimensions Drawing

Unit: (mm)

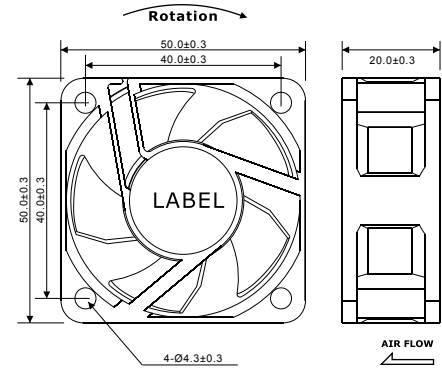

Model No	Bearing (*)	Rated Voltage (VDC)	Rated Current (A)	Power Consumption (Watts)	Speed (rpm)	Air Flow (CFM)	Static Pressure (mmH ₂ O)	Noise (dBA)	Curve
ED05020-05L*	○ ● ⊖	5	0.20	1.00	3200	10.84	2.07	20.8	1
ED05020-05M*	○ ● ⊖	5	0.30	1.50	3800	12.39	2.65	25.6	2
ED05020-05H*	○ ● ⊖	5	0.40	2.00	4400	14.01	3.28	29.6	4
ED05020-05HH*	○ ● ⊖	5	0.50	2.50	5000	15.58	4.00	33.0	5
ED05020-12L*	○ ● ⊖	12	0.09	1.08	4000	12.79	2.71	27.2	3
ED05020-12M*	○ ● ⊖	12	0.15	1.80	5000	15.58	4.00	33.0	5
ED05020-12H*	○ ● ⊖	12	0.25	3.00	6000	18.88	5.84	37.4	6
ED05020-12HH*	○ ● ⊖	12	0.34	4.08	7000	21.21	7.05	42.4	7

* Bearing Type: ○ Sleeve ● Two Ball ⊖ Hydro-Dynamic